



TANK CLEANING

SPRAY NOZZLE SOLUTIONS FOR
TANK & EQUIPMENT CLEANING



TABLE OF CONTENTS

- 3 The BETE Advantage
- 4-5 Tank Cleaning Product Selection Guide
- 6-11 Tank Cleaning Considerations
 - Soil Classifications
 - Types of Operating Principles
 - Mechanical Cleaning Action
 - Static vs Rotational Spray
- 12-15 Planning Guide for Effective Tank Cleaning
- 16-34 Spray Nozzles for Tank Cleaning
- 35 Tank Cleaning Lances
- 36-37 Manufacturing & Engineering Services

PERFORMANCE SPRAY ENGINEERING

BETE's decades of experience providing innovative tank and equipment cleaning solutions translates to **expert engineering that you can count on when it matters most.**

We design and manufacture a wide range of tank cleaning nozzles to precisely clean and sanitize tanks, drums, totes, and other vessels of all sizes in the food, beverage, pharmaceutical, and chemical processing industries. We design our rotational spray devices to optimize your cleaning process. They clean faster and consume less water and solvents than standard spray balls while reducing effluent discharge to save energy and resources.

BETE's mission goes beyond just selling spray nozzles. It is to provide engineered spray process solutions that exceed customer expectations in every detail. Our patented spray technologies are quality-inspected and field-proven to meet the high standards of third-party certifiers.

We make tens of thousands of different products, including automatic spray nozzles, air atomizing nozzles, misting nozzles, tank cleaning nozzles, spray dry nozzles, spray lances, and automated spray systems. Expect world-class customer support to help you choose the right solution and **make your tank cleaning project an efficient success.**



Spray Nozzles



Spray Fabrications



Spray Systems



Applications Engineering

















Spray Research

THE BETE ADVANTAGE



TANK CLEANING PRODUCT SELECTION GUIDE

Product Name				Small Tank Up to 2 m dia.	Mid-Size Tank 2 - 6 m dia.	Large Tank 6 - 30.5+ m dia.	Flow Rate L/min	Pressure bar	Minimum Entry Diameter	NPT Connection	Clip-On Connection	FDA Compliant	Spray Coverage	Max Temp.	Filtration
	Stationary	Reactionary Force	Rotary Jet	Light to Moderate Soil	Moderate Soil	Heavy Soil									
 HydroWhirl® Mini PVDF				Max Range 1.07 m			10.9 to 33.5	0.5 to 4	30.48 mm	1/2"		PVDF	360°	90°C	0.3mm/ 50 mesh
 HydroWhirl® Mini SS				Max Range 1.83 m			13.9 to 34.5	0.7 to 4	21.34 to 25.4 mm	3/8"	3/4"	316L SS	360°	130°C	0.3mm/ 50 mesh
 TW				Max Range 2.44 m			11.4 to 260	0.7 to 5	22.1 to 33.27 mm	3/8", 1/2" 1"			180°, 270°	288°C	
 LEM				Max Range 2.44 m			16 to 597	0.7 to 7	114.3 to 134.62	3/4", 1"			360°	288°C	
 CLUMP				Max Range 3.05 m			28.1 to 290	0.7 to 5	146.05 mm	3/4", 1"			360°	288°C	
 HydroClaw®				Max Range 3.05 m			119 to 442	1.5 to 3	60.96 to 73.66 mm	3/4", 1"	1", 1.5"	316L SS	360°	288°C	
 HydroWhirl® Disc				Max Range 3.35 m			96.3 to 227	0.7 to 4	99.06 mm	1"		316L SS	360°	90°C	
 HydroWhirl® Stinger				Max Range 3.66 m			4.15 to 380	0.7 to 4	16 to 48.26 mm		3/8", 1/2", 3/4", 1"	316L SS	360°	93°C	0.75mm/ 150 mesh
 HydroWhirl® Poseidon				Max Range 7.62 m			14.3 to 307	0.5 to 4	43.18 to 83.82 mm	3/8", 1/2" 3/4", 1", 1.5"		PTFE	180°, 360°	93°C	0.3mm/ 80 mesh
 HydroWhirl® Orbitor 100				Max Range 17.07 m			45 to 198	3 to 10	85.09 mm	3/4", 1"		316L SS	180°, 360°	93°C	0.2mm/ 35 mesh
 HydroWhirl® Orbitor				Max Range 39.62 m			80 to 600	3 to 10	127 mm	1.5"		316L SS	180°, 360°	93°C	0.015mm/ 50 mesh

SPRAY TECHNOLOGY FOR RELIABLE TANK CLEANING

Tank cleaning is an essential process for many industries and can be time-consuming and expensive without the correct solution for the given application. Cleaning tanks before and after storage or manufacturing processes is typical to avoid cross-contamination. BETE tank cleaning nozzles maximize cleaning efficiency by ensuring proper distribution of the cleaning media and maximizing impact from the system's available flow rate and pressure.

Our rotating spray devices clean more efficiently than traditional static spray balls and are proven to reduce effluent discharge, consume less water, and reduce waste. They save significant time and money over cleaning alternatives, such as "fill and drain" or manual entry, especially in hazardous environments. BETE specializes in spray technology for industrial and hygienic tank cleaning applications by offering a complete line of products for every size tank and soil type.



COMMON APPLICATIONS

- Bright Beer Tanks
- Brew Kettles
- Fermentations Tanks
- Mixers
- Cooking Kettles
- Large Commercial Ovens & Freezers
- Reactors
- Process Vessels
- Oil & Gas Storage Tanks
- Chemical Processing Tanks
- Spray Drying Tanks
- Totes, Drums, & Barrels
- Tanker Trucks & Railcars

TANK CLEANING CONSIDERATIONS

Tank cleaning applications vary by tank size and the type of soil. BETE offers a range of tank cleaning nozzles to fit these requirements. The following considerations will help determine which spray device is best for your application. Our engineering spray experts can assist with recommending solutions for achieving optimal cleaning performance and reliability.

SOIL CLASSIFICATIONS

Soil is an essential factor to consider when choosing a tank cleaning nozzle. BETE classifies soils into three classes ranging from light soil, moderate soil, and heavy soil. Every tank cleaning nozzle is assigned a soil classification, making it easier to select the right one. In some cases, a nozzle can have more than one class.

Class 1 - Light Soil

A liquid residue or light powder not anchored to the surface and that easily rinses away.

Examples: Powder mixes, light chemicals, oil-free liquids

Class 2 - Moderate Soil

Soil anchors to the surface and requires repetitive spray impact, temperature, and chemicals to remove.

Examples: Beverage concentrates, foods, light oils, dyes, flavorings

Class 3 - Heavy Soil

Soil heavily cakes onto the surface, and a longer dwell time is required to aid in the cleaning process. Solid jet streams work effectively on heavy soils.

Examples: Paint, asphalt, peanut butter, tar, heavy chemicals, tartrates, oils

OPERATING PRINCIPLES

We define BETE tank cleaning nozzles by three types of operating principles: stationary, reactionary force, and rotary jet. Each principle affects cleaning performance differently depending on the nozzle design.



STATIONARY

Stationary nozzles, also known as static nozzles, have no moving parts. The low-maintenance designs of our innovative HydroClaw and spiral TW provide sizable free passage superior to standard static spray balls. The TW series' versatile size range and narrow form ensure compatibility with small vessel openings, including bottles.



TW



LEM



CLUMP



HydroClaw®



REACTIONARY FORCE

These fluid-driven tank cleaning nozzles use the spray media's reaction force to drive the nozzle head's rotation. These provide complete 360° coverage and efficient cleaning through impact and repetition. Rotating nozzles increase tank washing efficiency over static spray balls, saving time and money by reducing water and cleaning agent consumption while decreasing downtime.



**HydroWhirl®
Mini SS**



**HydroWhirl®
Mini PVDF**



**HydroWhirl®
Stinger**



**HydroWhirl®
Disc**



**HydroWhirl®
Poseidon**



ROTARY JET

Rotary jets use the spray media flowing through internal gears on the body to rotate sets of high-impact jet nozzles through an efficient 2-axis orbital pattern, providing complete 360° coverage. The jet pattern nozzles on these assemblies provide significantly more impact and impingement force than other styles of tank cleaning nozzles, making them ideal for hard-to-clean residues and larger vessels.



HydroWhirl® Orbitor



HydroWhirl® Orbitor 100

FUNDAMENTALS OF CLEANING TECHNOLOGY

The fundamentals of cleaning technology use the relationship between time, temperature, chemical action, and mechanical force. Mechanical force plays a vital role in this relationship and defines the spray impact applied to the surface by the tank cleaning nozzle.

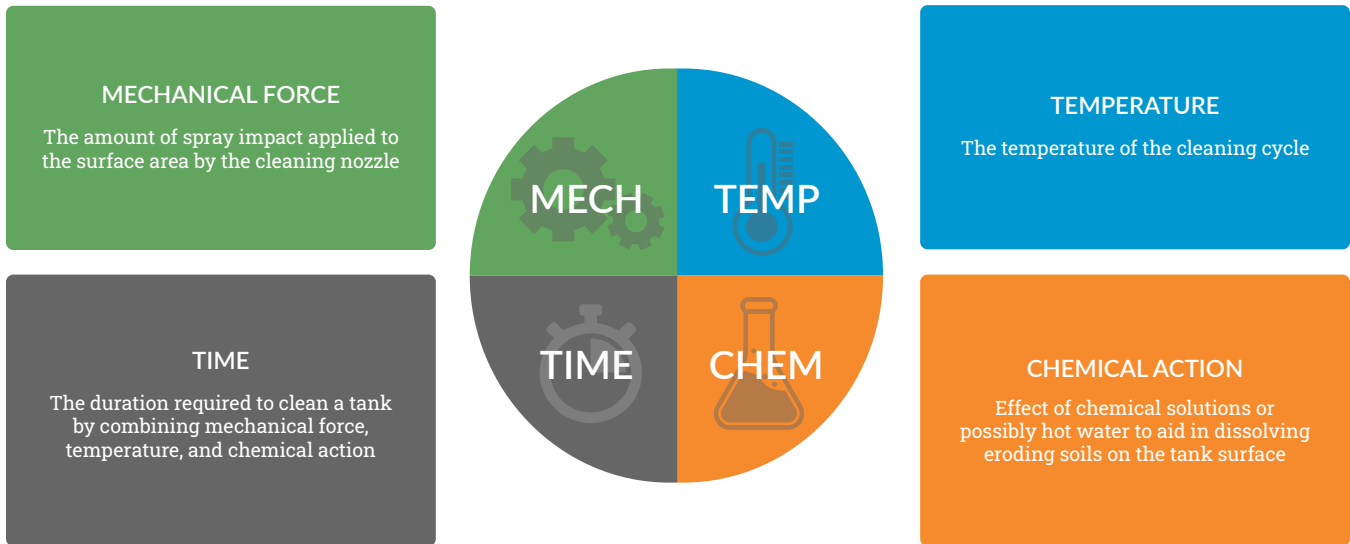

The greater mechanical force applied to the cleaning process will reduce time, temperature, and chemicals resulting in less water consumption and effluent discharge. The illustration below compares the mechanical force of a static spray ball with that of a rotary tank cleaning nozzle.

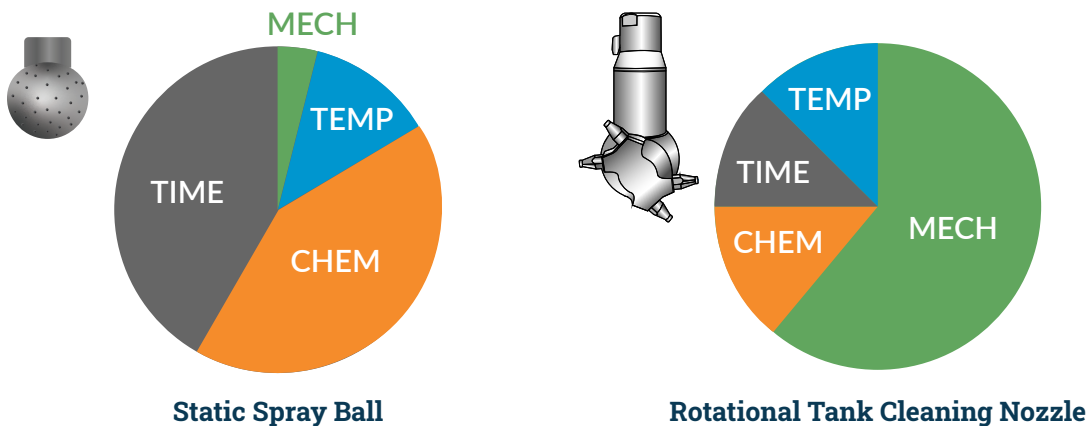

Static spray balls require more time to clean because they produce very little mechanical force and consume more chemicals and water, producing extra waste and increasing costs. Rotary tank cleaning nozzles provide greater mechanical force requiring less time for cleaning and benefiting from increased production and cost savings.

SPRAY IMPACT

STATIC VS ROTATIONAL SPRAY

Static spray balls are basic, economical, and less effective at cleaning than rotating spray devices. The jet streams produced by a static spray ball only penetrate a concentrated spot, and the remaining surface areas rely on shear stress for soil removal.

Rotating cleaning nozzles spray the entire tank surface in a fan-like pattern and provide better spray coverage with less reliance on shear stress, which helps to rinse but doesn't provide the economic benefits of impact. The fluid consumption for static spray balls is significantly greater than for rotational spray nozzles.

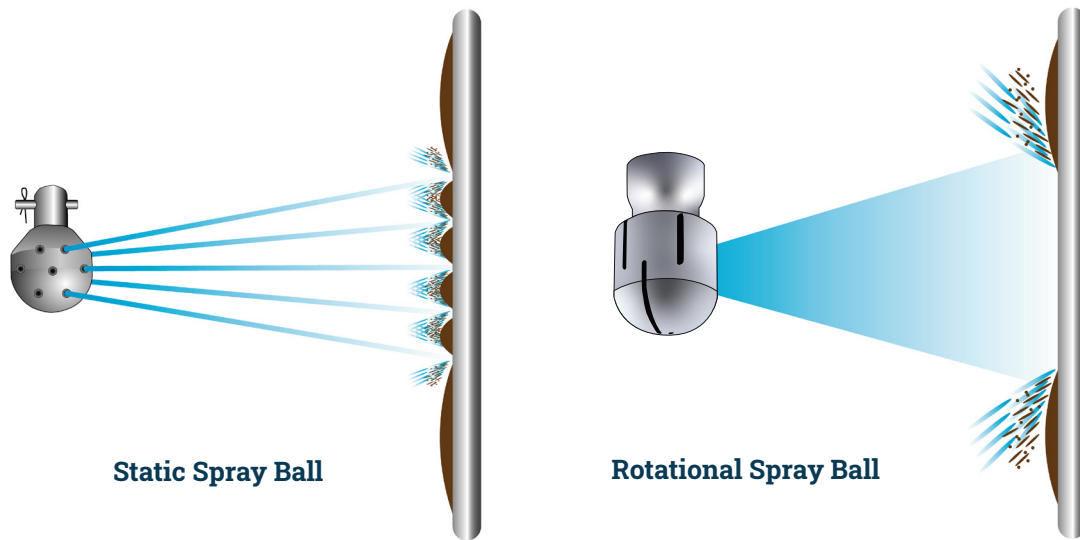

FLAT JET VS SOLID JET SPRAY

Reactionary force tank cleaning nozzles that produce flat, jet-like sprays form large droplets ideal for removing light to moderate soils.

These tank cleaning nozzles will cover more immediate surface area with shear stress and greater cascading action.

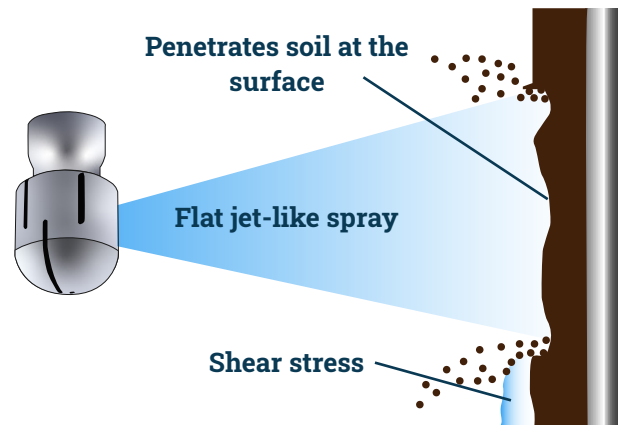

Rotary jet tank cleaning machines deliver the best impact for removing heavy soils. These tank cleaning machines operate on two or four-axis points that sweep the entire tank systematically to ensure complete surface coverage. The solid jet sprays, complemented with controlled rotation, allow for a longer spray dwell time that aids in penetrating difficult soils directly at the surface.

Rotary jet tank cleaning machines provide the greatest mechanical force for reducing cycle times, temperature, and chemical solvents.

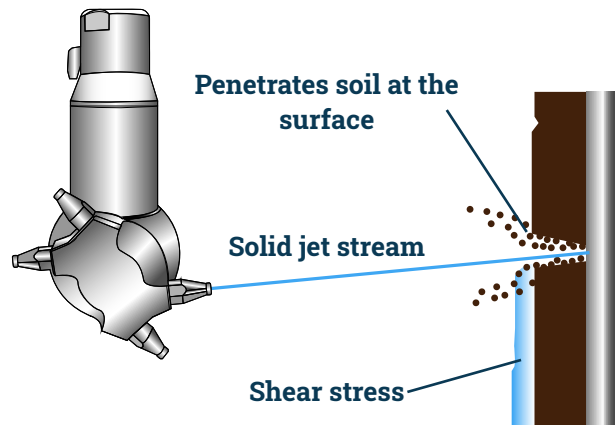

OPERATING PRESSURE VS SPRAY IMPACT

The operating pressure and distance between the nozzle and surface wall influence the formation of larger droplets with fluid-driven tank cleaning nozzles. These tank cleaning nozzles use the spray media's reaction force to drive the nozzle head's rotation to produce flat jet-like patterns that form large droplets at recommended pressures. Large droplets deliver more significant impact and spray coverage when cleaning the surface area of a tank.

If the operating pressure is too high, smaller droplets will produce less impact and result in atomization. For optimal cleaning performance, rotational spray nozzles must use the recommended pressures.

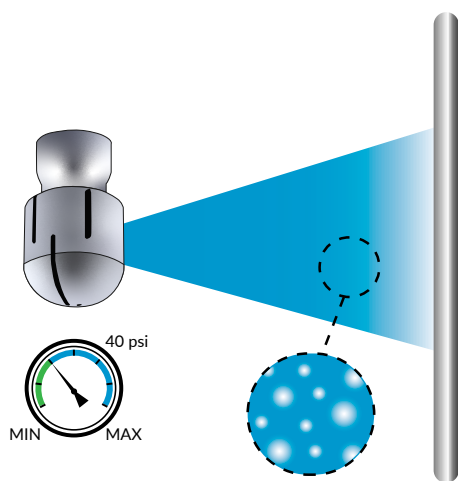

Operating at recommended pressure (40 psi/2.8 bar) larger droplets are formed.

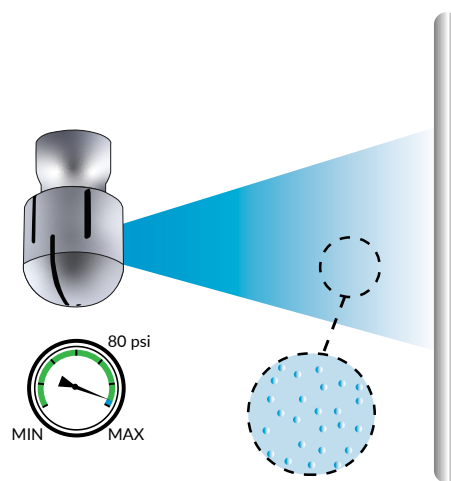

Operating above recommended pressure (80 psi/5.5 bar) small droplets produce atomization.



PLANNING GUIDE FOR EFFECTIVE TANK CLEANING

There are several factors to consider for effective tank cleaning. Tank size, pump capacity, and nozzle arrangement are just as important as selecting the best spray device for your cleaning application. Horizontal tanks have different cleaning challenges than vertical tanks and require engineered tank cleaning solutions.

This guide will help identify any challenges and provide recommendations to ensure your cleaning process is reliable. These simple strategies could reduce waste and resources, providing significant cost savings and increased productivity.

Our technical engineers' tank cleaning experience can recommend solutions with new or existing processes to help you obtain the optimum cleaning performance.

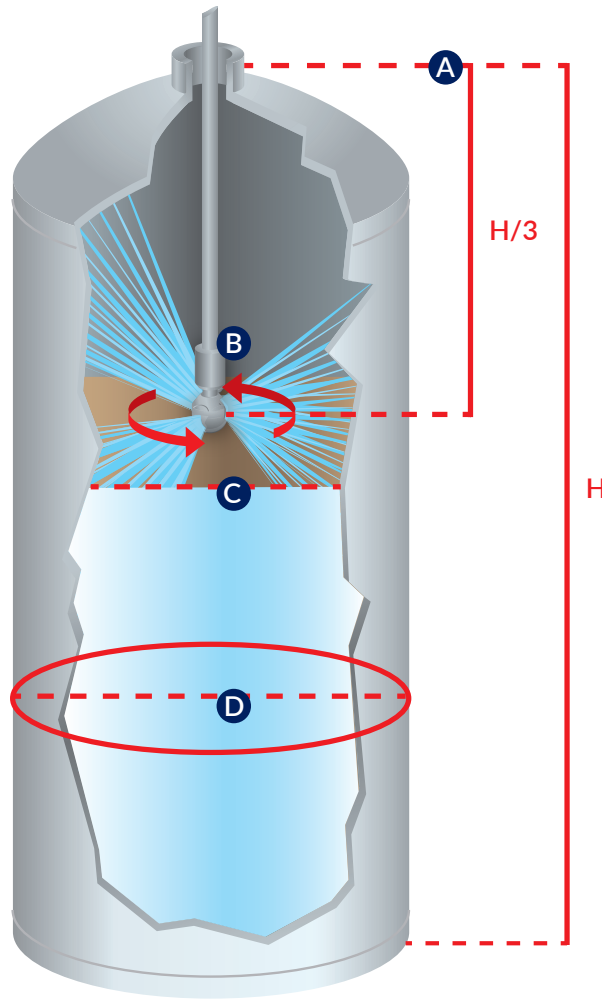

A. NOZZLE PLACEMENT

The nozzles should be positioned in the upper part of the tank when possible. However, nozzles placed too close to the ceiling of the tank will deflect off the tank ceiling, losing the cleaning impact.

Guideline for nozzle placement
(H/3) Nozzle = 1/3 Overall Tank Height (H)

B. PUMP CAPACITY & SIZE

The pipe size depends on the required flow rate and should be selected to ensure the pressure losses in the pipe system are as low as possible. The required static operating pressure must be directly available at the nozzle and match the pump power. Too much pressure loss in the pipe system may cause poor nozzle performance.

C. FILL LINE

When permanently mounting nozzles inside the tank, position them above the fill line. This prevents the nozzle from coming in contact with the product where bacteria buildup and cross-contamination can result. After the cleaning cycle, the nozzle should be removed because bacteria can adhere to the crevices.

D. TANK DIAMETER SIZE

Tanks come in various sizes and shapes. Selecting a suitable tank cleaning device depends on the soil type and the vessel's diameter. BETE offers tank cleaning nozzles designed to clean tanks up to 30.5+ m diameter. Use our Tank Cleaning Product Selection Guide on pages 4 and 5 to check the cleaning diameter for each nozzle and match your tank size.

DRAIN HOLE SIZE

The tank drainage by gravity rate is selected to prevent the liquid from rising during cleaning. Ensure the drain can handle whatever fluid volume enters the tank. In some cases, a recirculating pump may be advantageous if draining is problematic. The chart below indicates the capacity of fluid that the size of the drain hole can handle.

DRAIN HOLE SIZE (IN)	DRAIN HOLE SIZE (MM)	CAPACITY
1	25.4	22.71 L/min
1 ½	38.1	49.2 L/min
2	51	87.1 L/min
2 ½	63.5	132.5 L/min
3	76.2	189.3 L/min
4	101.6	329.3 L/min
5	127	530 L/min
6	152.4	772.2 L/min

SPRAY SHADOWS

Agitators, baffles, and pipes prevent the spray from reaching the areas behind them, known as spray shadowing. Installing multiple nozzles will provide the necessary coverage to clean these areas. Position the nozzles, so the sprays overlap and ensure proper cleaning.





CLEANING SOLUTIONS FOR HORIZONTAL TANKS

Installing tank cleaning nozzles vertically inside horizontal tanks can make cleaning cycles inefficient. The spray concentration remains at the tank's center and doesn't reach the tank's bulkhead. These areas will require manual cleaning, which can be hazardous to workers and result in bacteria buildup if not adequately cleaned.

BETE's tank cleaning mounting adapter positions the HydroWhirl Orbitor tank cleaning machine horizontally inside the tank, optimizing the direction of the spray pattern to effectively clean the bulkheads and reduce the cycle time by 50 percent. Because of their powerful solid jet streams, we recommend rotary jet tank cleaning machines for cleaning large horizontal tanks, rail cars, and tanker trucks.

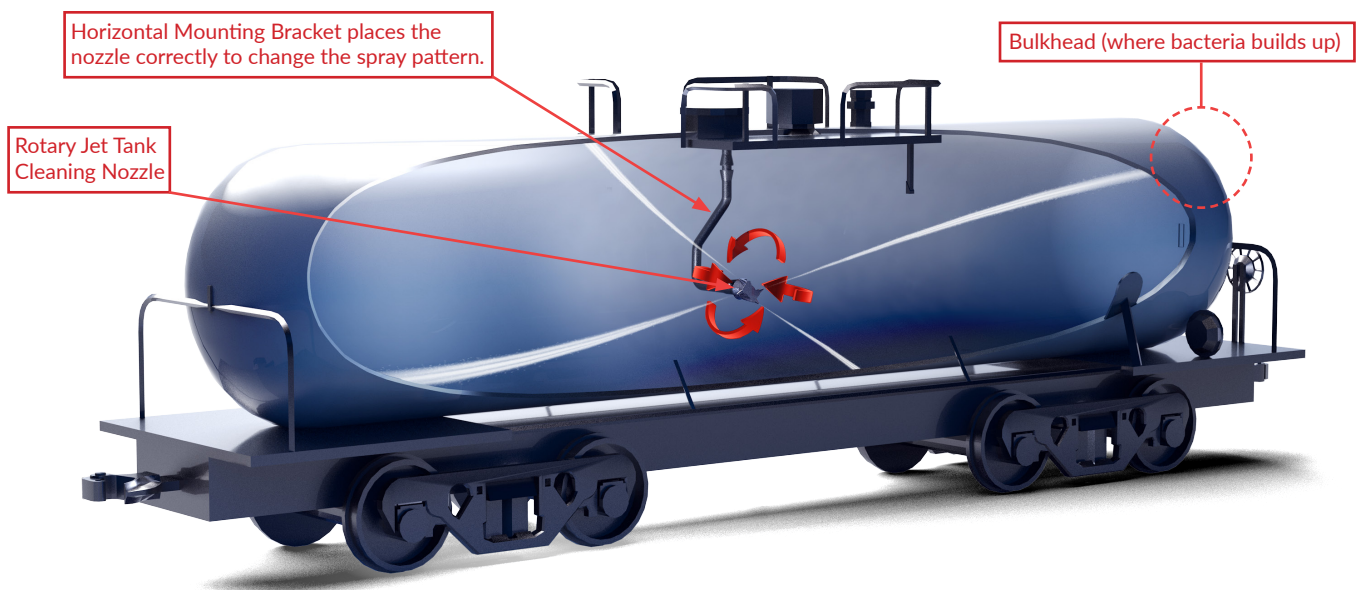



SPRAY NOZZLES FOR TANK CLEANING

BETE uses the latest spray technology for designing tank cleaning nozzles to ensure reliable and effective cleaning performance. Depending on the application, both stationary and rotating spray devices are offered because one nozzle's operating principle and design could be more effective than the other.

PREVENT DOWNTIME BY USING CLOG-RESISTANT NOZZLES

When particulates and filtration are a problem, we recommend stationary tank cleaning nozzles because they contain no moving parts and are resistant to clogging. A rotary spray device has internal mechanisms and could seize if any particulates become lodged inside the nozzle. The HydroClaw tank cleaning nozzle is ideal for passivating agents, such as nitric and citric acid, used in fermentation tanks.

SPRAY TECHNOLOGY DESIGNED TO DO MORE WITH LESS

For more difficult soils, rotating spray devices provide superior spray impact and consume 50% less water than static spray balls. These spray devices operate as free-spinning or controlled rotation. Rotary Jet tank cleaning machines have internal gears that slow the rotation of the nozzles, producing a longer dwell time on the surface for effective soil removal.

REDUCED WATER, WASTE, & ENERGY

- **50% water savings compared to static spray balls**
- **40% faster cleaning using less energy**
- **Less effluent discharge consumes fewer resources**
- **Precise and reliable cleaning prevents batch contamination**

Whether you have a small or large tank and require a simple rinse or heavy soil penetration, BETE offers a stationary or rotating tank cleaning nozzle for your application.

BETE tank cleaning nozzles are categorized by operating principle and soil class, specified on each product page. Use these symbols to identify the type of operating principle for each tank cleaning nozzle.



Stationary



Reactionary Force



Rotary Jet



HYDROWHIRL® MINI (HWM)

PVDF & STAINLESS STEEL REACTIONARY FORCE

Soil Class: 1 & 2

The HydroWhirl Mini nozzle directs the cleaning spray media or fluid through a rotating head at the tip of the spray assembly. The spray head produces a vigorous moving spray action impinging all surfaces inside the tank. The specially designed orifice produces a fan spray pattern that effectively breaks up and removes contaminants.

DESIGN FEATURES

- Compact design perfect for cleaning tight areas inside equipment and tanks up to 3 feet
- Cleans more quickly, uses less water, spray media, or fluid, and requires lower pressure than static spray balls
- Low flow and pressure require a smaller pump size resulting in lower operating costs
- Low maintenance bearing design is self-cleaning
- Available in corrosion-resistant PVDF material and FDA-Compliant 316L Stainless Steel material
- Hydrostatic wear-free slide bearing in PVDF material
- Unfilled PEEK slide-bearing provides greater longevity for stainless steel nozzle and is suitable for food and beverage applications

SPRAY CHARACTERISTICS

Spray Angles: Complete 360° spray

Max. Temperature: 90° C (PVDF) / 130° C (Stainless Steel)

Flow Rates: 10.9 to 33.5 LPM (PVDF) / 13.9 to 34.5 L/min (Stainless Steel)

Suggested Filtration: Line strainer with a mesh size of 0.3 mm/50 mesh

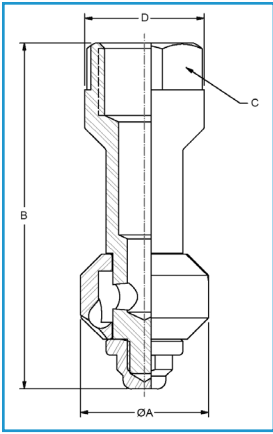

DIMENSIONS IN MILLIMETERS

Pipe Size	A	B	C	D	Weight (grams)
1/2"	30.5	81.3	22.9	27.9	31.1

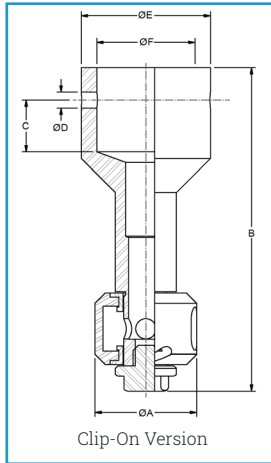
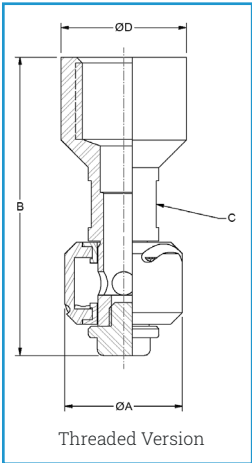

DIMENSIONS IN MILLIMETERS (CLIP-ON)

Tube Size	A	B	C	D	E	F	Weight (grams)	Min. Entry Dia
3/4"	20.3	63.5	10.2	2.54	25.4	20.3	31.1	31.2

DIMENSIONS IN MILLIMETERS (THREADED)

Pipe Size	A	B	C	D	Weight (grams)
3/8"	20.3	50.8	12.7	17.8	73.7

HYDROWHIRL® MINI FLOW RATES

Materials: PVDF

Female Connection Type	Nozzle Number	Spray Angles	Flow Rate (L/min) @ Differential Pressure (bar)						Maximum Free Passage	Coverage Dia @ 3 bar
			0.5	0.7	1	2	3	4		
			bar	bar	bar	bar	bar	bar		
1/2" FNPT	HWM-7.2	360°	10.9	13.0	15.8	23.0	28.7	33.5	1.91	1

HYDROWHIRL® MINI FLOW RATES

Materials: 316L Stainless Steel Body, PEEK Slide-Bearing

Female Connection Type	Nozzle Number	Spray Angles	Flow Rate (L/min) @ Differential Pressure (bar)					Maximum Free Passage	Coverage Dia @ 3 bar
			0.7	1	2	3	4		
			bar	bar	bar	bar	bar		
3/8" FNPT 3/4" Tube Clip-On	HWM-7.5	360°	13.9	16.7	24.0	29.7	34.5	1.52	2

Flow rates represent threaded connections with a 360° spray angle.



HYDROWHIRL® STINGER (HWS2)

SLOTTED SPRAY NOZZLE

Soil Class: 1 & 2

The fluid-driven HydroWhirl Stinger uses the reaction force of the spray media to drive the nozzle head. An innovative bearing assembly design provides improved balance and spray propagation for superior cleaning performance in a compact nozzle size.

DESIGN FEATURES

- Patent-pending no-weld design eliminates weak points and uneven surfaces
- Bearing assembly is centered within the spray head for improved balance and spray propagation
- Compact size with industry-leading flow rates fits 3/4"-2" Tri-Clamp openings
- Maintain better spray uniformity at lower pressures
- Unique patent-pending pipe thread technology flushes to reduce contamination and bacteria growth
- Ceramic Bearings for long service life and extreme chemical resistance
- Operates in any orientation

SPRAY CHARACTERISTICS

Spray Angles: Complete 360° spray

Max. Temperature: 93° C

Flow Rates: 4.15 to 380 L/min

Suggested Filtration: Line strainer with a mesh size 0.10 mm/150 mesh for nozzle number HWS2-4 and smaller. Line strainer with a mesh size 0.07 mm/200 mesh for nozzle number HWS2-7.5 and larger.

Note: HWS2 model will replace the original HWS model. Contact BETE for replacement part numbers.

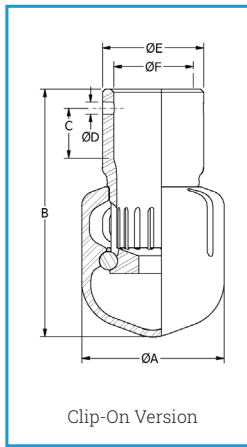
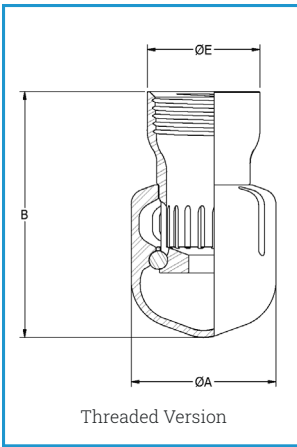

DIMENSIONS IN MILLIMETERS (CLIP-ON)

Tube Size	A	B	C	D	E	F	Weight (grams)	Min Tank Entry Dia
1"	46.7	86.4	21.3	3.96	33.5	25.4	340	46.7
3/4"	34.3	72.2	12.7	2.18	26.9	19.0	198	34.3
1/2"	21.6	48.3	12.4	2.18	21.3	12.7	85	30.2
3/8"	15.2	34.9	8.61	2.18	14.2	9.52	23	22.9

DIMENSIONS IN MILLIMETERS (THREADED)

Pipe Size	A	B	E	Weight (grams)	Min Tank Entry Dia
1"	46.7	80.0	36.6	298	46.7
3/4"	34.3	69.1	29.2	146	34.3
1/2"	34.3	60.3	24.1	134	34.3
3/8"	21.6	45.2	19.1	40	21.6
1/8"	15.2	31.7	12.8	28	15.2

HYDROWHIRL® STINGER FLOW RATES

Materials: 316L Stainless Steel Body, Ceramic Bearings

Female Connection Type	Nozzle Number	Spray Angles	Flow Rate (LPM) @ Differential Pressure (bar)					Maximum Free Passage	Coverage Dia @ 2 bar
			0.7	1	2	3	4		
			bar	bar	bar	bar	bar		
1/8" FNPT, BSP 3/8" Tube Clip-On	HWS2-2.1	360°	4.15	4.92	6.83	8.27	9.48	0.64	0.6
	HWS2-4		7.80	9.27	13.0	15.8	18.1	0.99	2
	HWS2-7.5		14.6	17.4	24.3	29.6	34.0	1.60	2
3/8" FNPT, BSP 1/2" Tube Clip-On	HWS2-10	360°	18.8	22.6	32.1	39.5	45.7	0.61	2
	HWS2-12		23.7	28.1	39.0	47.3	54.2	0.99	3
	HWS2-17		32.8	39.1	54.9	67.1	77.3	2.00	3
1/2" FNPT, BSP	HWS2-20	360°	39.0	46.3	64.8	78.9	90.6	0.99	3
	HWS2-26		49.0	58.8	83.6	103	119	1.63	3
3/4" FNPT, BSP 3/4" Tube Clip-On	HWS2-20	360°	39.0	46.3	64.8	78.9	90.6	0.99	3
	HWS2-26		49.0	58.8	83.6	103	119	1.63	3
1" FNPT, BSP 1" Tube Clip-On	HWS2-33	360°	63.5	75.7	107	130	150	0.79	3
	HWS2-55		105	126	177	217	251	1.63	4
	HWS2-66		127	152	213	260	300	2.39	4
	HWS2-84		165	195	272	331	380	3.18	4

Flow rates represent threaded connections with a 360° spray angle.

Flow rates may vary for other connection types and spray angles.



HYDROWHIRL® DISC (HWD)

POWERFUL SUBMERSIBLE ROTATING TANK CLEANER

Soil Class: 1 & 2

The HydroWhirl Disc nozzle directs the cleaning spray media or fluid through a rotating head at the tip of the spray assembly. This reactionary force produces a vigorous moving spray action impinging all surfaces inside the tank. The HydroWhirl Disc is clog-resistant and can be entirely submersed while providing powerful cleaning action.

DESIGN FEATURES

- Fluid-driven, self-flushing
- Fully submersible, clog-resistant
- Powerful flat spray nozzle inserts
- Hydrostatic wear-free PTFE slide bearing for longer life
- Made from FDA-compliant, 316L SS
- For cleaning medium-sized tanks

SPRAY CHARACTERISTICS

Spray Angles: Complete 360° spray

Max. Temperature: 90° C

Flow Rates: 96.3 to 227 L/min

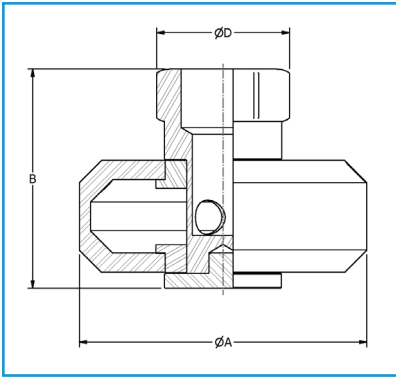

DIMENSIONS IN MILLIMETERS

Pipe Size	A	B	D	Weight (grams)
1"	98.4	74.8	40.6	1162

HYDROWHIRL® DISC FLOW RATES

Materials: Stainless Steel Body: PEEK Slide-Bearing

Female Connection Type	Nozzle Number	Spray Angles	Flow Rate (LPM) @ Differential Pressure (bar)					Maximum Free Passage	Coverage Dia @ 2 bar
			0.7	1	2	3	4		
			bar	bar	bar	bar	bar	mm	m
1" FNPT	HWD-50	360°	96.3	115	162	198	227	3.30	3



HYDROWHIRL® POSEIDON (HWP)

PTFE REACTIONARY FORCE

Soil Class: 2 & 3

The HydroWhirl Poseidon nozzle directs the cleaning spray media or fluid through a rotating head at the tip of the spray assembly. This nozzle design produces a slow-moving, high-impact spray action against the tank's internal surfaces. The HydroWhirl Poseidon nozzle head uses impact and repetition to break up and wash away contamination quickly.

DESIGN FEATURES

- Durable PTFE material construction withstands extreme chemical and elevated temperature environments
- Cleans more quickly, uses less water, spray media, or fluid, and requires lower pressure than static spray balls
- Slow rotation speed enables longer spray dwell time, increasing spray impact along with efficient cycle times
- Easy to disassemble, inspect, and reassemble with basic hand tools

SPRAY CHARACTERISTICS

Spray Angles: Complete 360° spray

Max. Temperature: 93°C

Flow Rates: 14.3 to 307 L/min

Suggested Filtration: Line strainer with a mesh size of 0.045 mm/325 mesh

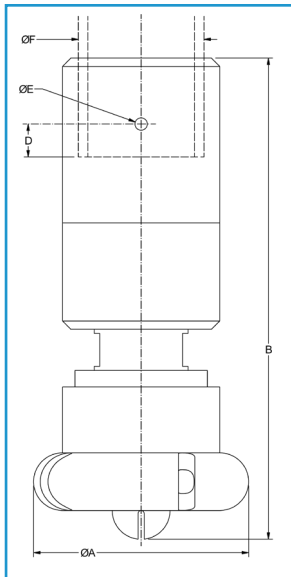

DIMENSIONS IN MILLIMETERS

Nozzle Number	Female Connection Size	A	B	D	E	F (Pipe)	F (Tube)	F (DN)	Weight (grams)
HWP-10	1/4" FNPT, BSP, Pipe Clip-On, DN10	42.7	100	12.7	2.29	13.7		13.0	85.1
	3/8" FNPT, BSP, Pipe Clip-On, DN15					17.3		19.0	
	1/2" FNPT, BSP, Pipe/Tube Clip-On, DN15					21.3	0.50	19.0	
	3/4" Tube Clip-On						0.75		
HWP-23 HWP-28	3/8" FNPT, BSP, Pipe Clip-On, DN15	49.5	105	12.7	4.06	17.3		19.0	113
	1/2" FNPT, BSP, Pipe Clip-On, DN20					21.3		23.0	
	3/4" FNPT, BSP, Pipe/Tube Clip-On, DN20					26.7	0.75	23.0	
	1" Tube Clip-On						1.00		
HWP-32 HWP-37	1/2" FNPT, BSP, DN20	76.2	163	12.7	4.83	21.3		23.0	595
	3/4" FNPT, BSP, Pipe Clip-On, DN25					26.7		29.0	
	1" FNPT, BSP, Pipe/Tube Clip-On, DN25					33.5	1.00	29.0	
	1 1/4" Tube Clip-On						1.25		
HWP-48 HWP-55 HWP-65 HWP-73	1" FNPT, BSP, Pipe Clip-On, DN40	88.8	185	12.7	4.83	33.5		41.0	822
	1 1/4" FNPT, BSP, Pipe Clip-On, DN40					42.2		41.0	
	1 1/2" FNPT, BSP, Pipe/Tube Clip-On, DN40					48.3	1.50	41.0	
	1 3/4" Tube Clip-On						1.75		

HYDROWHIRL® POSEIDON® FLOW RATES

Materials: Nozzle: PTFE Body, 316 Stainless Steel Retaining Clip

Female Connection Type	Nozzle Number	Spray Angles	Flow Rate (L/min) @ Differential Pressure (bar)						Maximum Free Passage	Coverage Dia @ 3 bar
			0.5	1	1.5	2	3	4		
			bar	bar	bar	bar	bar	bar		
1/4" FNPT, BSP, Pipe Clip-On, DN10 3/8" FNPT, BSP, Pipe Clip-On, DN15 1/2" FNPT, BSP, Pipe/Tube Clip-On, DN15 3/4" Tube Clip-On	HWP-10	360°	14.3	20.3	24.9	28.8	35.4	40.9	1.52	2
3/8" FNPT, BSP, Pipe Clip-On, DN15 1/2" FNPT, BSP, Pipe Clip-On, DN20 3/4" FNPT, BSP, Pipe/Tube Clip-On, DN20 1" Tube Clip-On	HWP-23	360°	30.3	43.1	52.9	61.2	75.2	87.0	1.52	3
	HWP-28		34.6	49.0	60.0	69.3	84.9	98.0		4
1/2" FNPT, BSP, DN20 3/4" FNPT, BSP, Pipe Clip-On, DN25 1" FNPT, BSP, Pipe/Tube Clip-On, DN25 1 1/4" Tube Clip-On	HWP-32	360°	37.5	53.8	66.5	77.2	95.4	111	1.52	4
	HWP-37		48.5	69.2	85.2	98.7	122	141		5
1" FNPT, BSP, Pipe Clip-On, DN40 1 1/4" FNPT, BSP, Pipe Clip-On, DN40 1 1/2" FNPT, BSP, Pipe/Tube Clip-On, DN40 1 3/4" Tube Clip-On	HWP-48	360°	66.0	94.0	116	134	165	191	1.52	7
	HWP-55		75.4	107	132	153	188	218		7
	HWP-65		98.7	140	171	198	243	281	2.29	8
	HWP-73		108	153	187	216	265	307		8

Flow rates represent threaded connections with a 360° spray angle.

Flow rates may vary for other connection types and spray angles.



HYDROWHIRL® ORBITOR 100 (HWO100)

HIGH-IMPACT ROTARY JET TANK CLEANING MACHINE

Soil Class: 3

The HydroWhirl Orbitor 100 is a compact, powerful, versatile tank cleaning machine designed to meet the high standards required in the food, beverage, and chemical processing industries. Rotary jet tank cleaning machines use the spray media flowing through internal gears on the body to rotate sets of high-impact jet nozzles through an efficient 2-axis orbital pattern, providing complete 360° coverage.

DESIGN FEATURES

- Self-cleaning, Self-lubricating
- Ideal for small to medium tanks with heavy soils.
- Easily fits through Ø4" (100 mm) openings or Ø3.35" (85 mm) when the nozzle head is vertically aligned
- Easy to repair and maintain on-site
- Designed with minimum moving parts to ensure extended operating life
- Solid stream jets provide high impact
- Available in four nozzle configurations

SPRAY CHARACTERISTICS

Spray Angles: Complete 360° spray

Max. Temperature: 93°C

Flow Rates: 44.8 to 198 L/min

Suggested Filtration: Line strainer with a mesh size of 0.075 mm/200 mesh



All HydroWhirl Orbitor 100 tank cleaning machines are available with ATEX approval

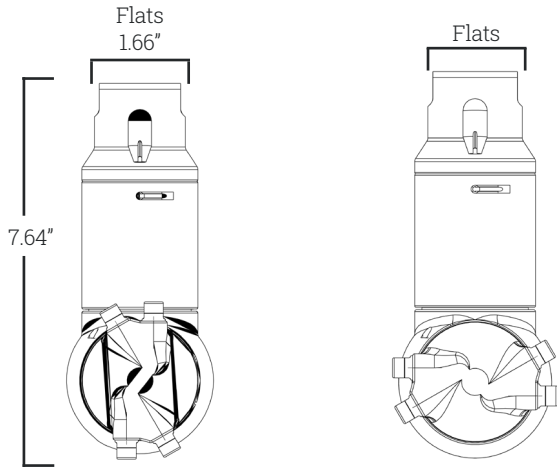

Vertical Nozzle Head Alignment Clearance Diameter: 3.35"
 Horizontal Nozzle Head Alignment Clearance Diameter: 3.94"

Max. Working Temp.: 200° F (95 °C)
Max. Ambient Temp.: 285° F (140 °C)
Weight: 2.5 kg
Materials:
 Housing and Nozzle Head: 316L
 Gears: PEEK + 316 SS
 Bushings/Seals: Carbon Filled PTFE

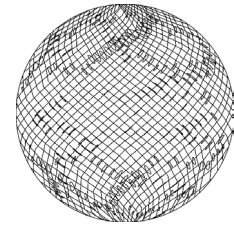

Orbitor 4 nozzle spray pattern

HYDROWHIRL® ORBITOR 100 - 4 NOZZLE FLOW RATES

Nozzle Number	4 X 3 mm			4 X 4 mm			4 X 5 mm			4 X 6 mm		
	3/4" and 1" FNPT, BSP			3/4" and 1" FNPT, BSP			3/4" and 1" FNPT, BSP			3/4" and 1" FNPT, BSP		
Female Connection Size	Flow (L/min)	Jet Length (m)	Cycle Time (min)	Flow (L/min)	Jet Length (m)	Cycle Time (min)	Flow (L/min)	Jet Length (m)	Cycle Time (min)	Flow (L/min)	Jet Length (m)	Cycle Time (min)
3	44.8	1.00	6.00	66.7	2.00	5.50	88.5	2.50	4.40	115	3.00	4.00
4	51.7	1.50	5.40	75.0	2.50	4.80	99.5	3.00	4.00	127	3.50	3.50
5	58.5	2.00	4.80	84.5	3.00	4.20	110	3.50	3.50	138	4.00	3.10
6	65.0	2.00	4.30	93.3	3.00	3.70	120	3.50	3.10	152	4.00	2.70
7	71.7	2.50	4.00	102	3.50	3.30	130	4.00	2.70	163	4.50	2.40
8	78.1	2.50	3.60	110	3.50	2.90	140	4.00	2.40	175	4.50	2.10
9	85.0	3.00	3.20	118	4.00	2.70	148	4.50	2.20	187	5.00	1.90
10	90.0	3.50	2.90	127	4.00	2.50	157	4.50	2.00	198	5.00	1.70

Performance may vary with ATEX models.



HYDROWHIRL® ORBITOR 100 XC

HIGH-IMPACT SLOW ROTATION TANK CLEANING MACHINE

Soil Class: 3

The HydroWhirl Orbitor 100 XC (Extreme Clean) tank cleaning machines yield high impact with slower rotation. The longer dwell time on the surface area is ideal for the effective removal of heavy residues.

DESIGN FEATURES

- High impact and slower rotation yield longer spray dwell time on the target surface for effective soil removal
- All models available with ATEX approval
- Easily field-serviced to reduce maintenance costs
- Minimum moving parts extend operating life
- Self-cleaning; self-lubricating
- Ideal for small to medium tanks, easily fits through Ø4" (100 mm) openings or Ø3.35" (85 mm) when nozzle head vertically aligned

SPRAY CHARACTERISTICS

Spray Angles: Complete 360° spray

Max. Temperature: 93°C

Flow Rates: 44.8 to 198 L/min

Suggested Filtration: Line strainer with a mesh size of 0.075 mm/200 mesh



All HydroWhirl Orbitor 100 tank cleaning machines are available with ATEX approval

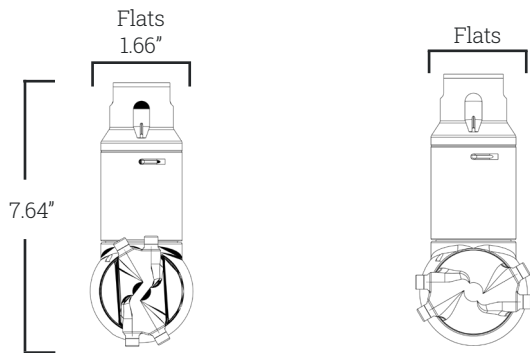

Vertical Nozzle Head Alignment Horizontal Nozzle Head Alignment
 Clearance Diameter: 3.35" Clearance Diameter: 3.94"

Max. Working Temp.: 200° F (95 °C)
Max. Ambient Temp.: 285° F (140 °C)
Weight: 2.5 kg
Materials:
 Housing and Nozzle Head: 316L
 Gears: PEEK + 316 SS
 Bushings/Seals: Carbon Filled PTFE

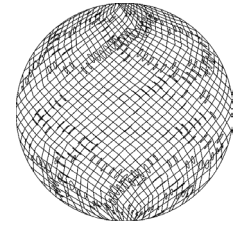

Orbitor 4 nozzle
 spray pattern

HYDROWHIRL® ORBITOR 100 XC - 4 NOZZLE FLOW RATES

Nozzle Number	4 X 3 mm			4 X 4 mm			4 X 5 mm			4 X 6 mm		
Female Connection Size	3/4" and 1" FNPT, BSP			3/4" and 1" FNPT, BSP			3/4" and 1" FNPT, BSP			3/4" and 1" FNPT, BSP		
Pressure (psi)	Flow (LPM)	Jet Length (mm)	Cycle Time (min)	Flow (LPM)	Jet Length (mm)	Cycle Time (min)	Flow (LPM)	Jet Length (mm)	Cycle Time (min)	Flow (LPM)	Jet Length (mm)	Cycle Time (min)
45	48.8	1.00	19.5	62.5	2.00	25.5	91.6	2.50	16.3	115	3.00	21.5
60	53.8	1.50	16.8	72.7	2.50	21.6	102	3.00	14.1	127	3.50	18.7
75	59.4	2.00	14.6	85.5	3.00	18.3	112	3.50	12.2	138	4.00	16.3
90	65.1	2.00	12.8	91.6	3.00	15.7	122	3.50	10.9	152	4.00	14.3
100	69.3	2.50	11.8	97.3	3.50	14.2	128	4.00	10.2	163	4.50	13.2
115	76.1	2.50	10.7	106	3.50	12.5	137	4.00	9.60	175	4.50	11.8
130	82.9	3.00	10.0	113	4.00	11.5	146	4.50	9.50	187	5.00	10.8
145	90.1	3.50	9.70	120	4.00	11.0	155	4.50	9.80	198	5.00	10.3



HYDROWHIRL® ORBITOR (HWO)

HIGH-IMPACT ROTARY JET TANK CLEANING MACHINE

Soil Class: 3

The HydroWhirl Orbitor is a versatile tank cleaning machine designed for the most challenging cleaning applications in the food, beverage, and chemical processing industries. Rotary jet tank cleaning machines use the spray media flowing through internal gears on the body to rotate sets of high-impact jet nozzles through an efficient 2-axis orbital pattern, providing complete 360° coverage.

DESIGN FEATURES

- Self-cleaning, Self-lubricating
- Ideal for use in large tanks for difficult-to-remove soils
- Easy to repair and maintain on-site
- Designed with minimum moving parts to ensure extended operating life
- Solid stream jets provide high impact
- Two-axis orbital spray pattern provides controlled rotation for complete 360° spray coverage
- Available in 2 or 4 nozzle configurations

SPRAY CHARACTERISTICS

Spray Angles: Complete 360° spray

Max. Temperature: 93°C

Max. Free Passage: 0.04 in

Flow Rates: 80 to 600 L/min

Suggested Filtration: Line strainer with a mesh size of 0.075 mm/200 mesh



All HydroWhirl Orbitor tank cleaning machines are available with ATEX approval

Max. Working Temp.: 200 °F (95 °C)
Max. Ambient Temp.: 285 °F (140 °C)
Weight: 7.5 kg

Minimum opening size is 5" for either
 2-nozzle or 4-nozzle standard-capacity
 model with jets vertically aligned.

Materials:

Housing and Nozzle Head: 316L
 Gears: PEEK + 316 SS
 Bushings/Seals: Carbon Filled PTFE

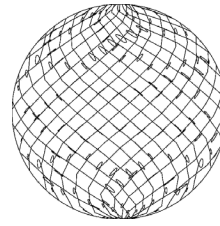

Orbitor 2 nozzle
spray pattern

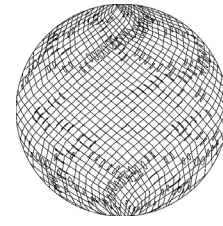

Orbitor 4 nozzle
spray pattern

HYDROWHIRL® ORBITOR - 4 NOZZLE FLOW RATES

Nozzle Number	4 X 4.2 mm			4 X 5 mm			4 X 6 mm			4 X 7 mm			4 X 8 mm		
	1 - 1/2" NPT/BSP			1 - 1/2" NPT/BSP			1 - 1/2" NPT/BSP			1 - 1/2" NPT/BSP			1 - 1/2" NPT/BSP		
Pressure (psi)	Flow (GPM)	Jet Length (ft)	Cycle Time (min)	Flow (GPM)	Jet Length (ft)	Cycle Time (min)	Flow (GPM)	Jet Length (ft)	Cycle Time (min)	Flow (GPM)	Jet Length (ft)	Cycle Time (min)	Flow (GPM)	Jet Length (ft)	Cycle Time (min)
45	22.6	9.5	11	31.4	13.1	13	38.6	17.4	15.5	59.1	21.3	11.4	68.3	23.6	15.5
60	26.5	9.8	9.3	36.4	13.8	10.8	45.7	18.7	12.9	67.7	23.3	9.8	79.0	26.2	12.9
75	30.0	11.5	7.9	40.8	15.4	9.4	52.1	20.3	11	75.2	25.3	8.7	88.4	29.5	11
90	33.3	13.1	6.9	44.8	17.1	8	58.0	23.0	9.5	81.9	27.9	8.1	96.9	32.5	9.5
100	35.3	16.4	6.3	47.2	20.7	7.3	61.8	26.2	8.4	86.0	30.8	7.5	102	34.8	8.5
115	38.1	20.3	5.8	50.8	24.6	6.8	67.0	30.8	7.6	91.9	33.8	7.1	110	36.7	7.8
130	40.8	23.3	5.6	54.0	27.9	6.5	72.1	33.8	7	97.3	36.7	6.9	117	40.0	7
145	43.4	25.6	5.5	57.2	29.5	6.4	76.8	36.7	6.9	102	39.4	6.6	123	42.6	6.9

HYDROWHIRL® ORBITOR - 2 NOZZLE FLOW RATES

Nozzle Number	2 x 6 mm			2 X 7 mm			2 X 8 mm			*2 X 10 mm			*2 X 12.5 mm		
	1 - 1/2" NPT/BSP			1 - 1/2" NPT/BSP			1 - 1/2" NPT/BSP			1 - 1/2" NPT/BSP			1 - 1/2" NPT/BSP		
Pressure (psi)	Flow (GPM)	Jet Length (ft)	Cycle Time (min)	Flow (GPM)	Jet Length (ft)	Cycle Time (min)	Flow (GPM)	Jet Length (ft)	Cycle Time (min)	Flow (GPM)	Jet Length (ft)	Cycle Time (min)	Flow (GPM)	Jet Length (ft)	Cycle Time (min)
45	21.5	18.0	33	26.1	21.3	37.5	33.5	23.6	25.7	59.1	32.1	41	89.4	33.1	26.8
60	25.4	19.7	27.2	31.3	23.6	31.6	39.3	26.2	22.9	68.7	34.4	34.2	103	36.7	24
75	28.8	20.7	24.7	36.0	25.9	28.2	44.4	29.5	20.5	77.2	37.7	30.5	115	39.7	21.7
90	31.9	23.0	22.6	40.4	27.9	25.8	49.1	32.5	18.9	84.9	41.7	28	126	44.0	19.8
100	33.9	26.2	21	43.2	29.2	24	52.0	34.8	17.5	89.8	45.6	26	133	48.5	18.4
115	36.7	29.5	19.5	47.2	30.2	22.3	56.2	36.7	16.4	96.6	49.9	24.5	143	53.8	17.2
130	39.4	33.5	18.4	51.1	37.0	21	60.1	40.0	15.6	103	55.8	23.2	152	60.0	16.3
145	41.9	37.7	17.4	54.7	40.4	20	63.8	42.6	14.9	109	61.7	22	160	65.9	15.5

Performance may vary with ATEX models

*High Capacity Jet Machine



HYDROCLAW® (HC)

SUPERIOR CLOG-RESISTANT STATIONARY NOZZLE

Soil Class: 1 & 2

The unique HydroClaw design has no moving parts. It allows the passage of particles over 1/4", three times the free passage of a comparable spray ball while providing a more significant spray impact. This stationary tank cleaning nozzle operates on low pressure/high flow for faster cleaning and reduced cycle times using less water and solvents.

DESIGN FEATURES

- Patented, clog-resistant
- Self-cleaning, Self-lubricating
- Made from FDA-compliant 316L SS material
- Clip-on nozzles include a low-profile retaining pin for secure connection
- Laser welded for durability
- Ideal for passivating agents, such as nitric and citric acid, used in fermentation tanks.

SPRAY CHARACTERISTICS

Spray Angles: Complete 360° spray

Max. Temperature: 288°C

Flow Rates: 119 to 442 L/min

DIMENSIONS IN MILLIMETERS

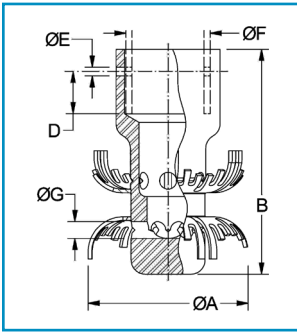

Nozzle Number	Female Connection Size	A	B	D	E	F	Weight (grams)
HC-42	3/4" FNPT	60.5	91.2				416
	3/4" G	60.5	91.2				413
	1" Tube Weld-On	60.5	91.2				325
	1 1/2" Tube Clip-On	60.5	102	19.1	4.1	38.1	504
	1" Tube Clip-On	60.5	19.1	19.1	4.1	25.4	391
	3/4" Pipe Clip-On	60.5	91.2	19.1	4.1	26.7	382
	DN20 Tube Clip-On	60.5	91.2	19.1	4.1	23.1	416
HC-100	1" FNPT	73.2	102				649
	1"	73.2	102				635
	1 1/2" Tube Weld-On	73.2	102				425
	1 1/2" Tube Clip-On	73.2	102	19.1	4.1	38.1	527
	DN40 Tube Clip-On	73.2	102	19.1	4.1	40.0	437
	1" Pipe Clip-On	73.2	102	19.1	4.1	33.5	598

HYDROCLAW® FLOW RATES

Materials: 316L Stainless Steel

Female Connection Type	Nozzle Number	Spray Angles	Flow Rate (L/min) @ Differential Pressure (bar)				Maximum Free Passage mm	Coverage Dia @ 3 bar m
			1.5	2	2.5	3		
			bar	bar	bar	bar		
3/4" FNPT, G	HC-42	360°	119	136	152	166	6.40	2
1" Tube Weld-on			119	136	152	166		
1" Tube Clip-On			125	145	161	176		
1 1/2" Tube Clip-On			125	145	161	176		
3/4" Pipe Clip-On			125	145	161	176		
DN20 Tube Clip-On			125	145	161	176		
1" FNPT, G	HC-100	360°	279	322	360	394	7.60	3
1 1/2" Tube Weld-on			279	322	360	394		
1 1/2" Tube Clip-On			312	361	403	442		
DN40 Tube Clip-On			312	361	403	442		
1" Pipe Clip-On			312	361	403	442		

Clip-on flow rates may vary depending on actual O.D. of installation tube or pipe.



TW

STATIONARY SPIRAL

Soil Class: 1 & 2

DESIGN FEATURES

- Clog-resistant spiral design
- Greater spray impact than traditional static spray balls
- Can be used for steam injection and passivation
- Compact design fits in small openings
- Unique patterns that spray in opposing directions



TW 20

TW 1

SPRAY CHARACTERISTICS

Spray Angles: 180°, 270°

Flow Rates: 11.4 to 260 L/min

Max Temperature: 288° C

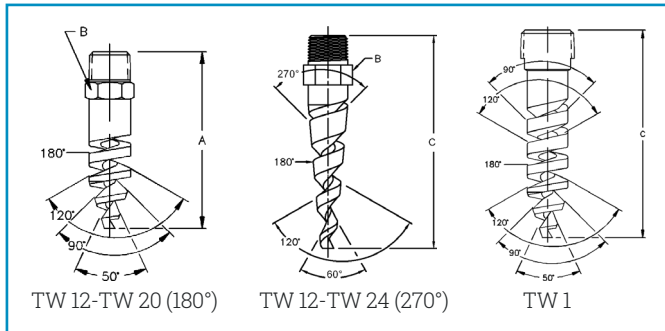

DIMENSIONS IN MILLIMETERS

Pipe Size	A 180°	B	C 270°	Wt. (grams)
3/8"	73.0	17.5	92.1	49.6
1/2"		22.2	108	11
1"		28.7	146	298

TW FLOW RATES

Materials: Brass, 316 Stainless Steel

Male Connection Type	Nozzle Number	Available Spray Angles	K Factor	Flow Rate (L/min) @ Differential Pressure (bar)						Approx. Orifice Dia mm	Approx. Free Pass Dia mm	Scrubbing Dia m	Rinsing Dia m
				0.7	1	2	3	4	5				
				bar	bar	bar	bar	bar	bar				
3/8" NPT/BSP	TW-12	180° 270°	13.7	11.4	13.7	19.3	23.7	27.3	30.6	4.83	3.30	0.3	0.9
	TW-14	180° 270°	18.5	15.4	18.5	26.1	32.0	36.9	41.3	5.59	3.30	0.3	1
	TW-16	180° 270°	24.2	20.2	24.2	34.2	41.8	48.3	54.0	6.35	3.30	0.6	1
	TW-20	180° 270°	37.6	31.5	37.6	53.2	65.1	75.2	84.1	7.87	3.30	0.9	2
1/2" NPT/BSP	TW-24	270°	54.9	46.0	54.9	77.7	95.1	110	123	10.4	4.32	1	3
1" NPT/BSP	TW-1	270°	116	97.2	116	164	201	232	260	14.2	5.08	2	6

Flow Rate (GPM) = $K\sqrt{PSI}$

Spray angle performance varies with pressure. Contact BETE for specific data on critical applications.



CLUMP

STATIONARY MANIFOLD

Soil Class: 1 & 2

DESIGN FEATURES

- Each nozzle in the manifold cluster is a BETE MaxiPass® clog-resistant full cone nozzle
- Other BETE nozzles can be used
- Six nozzles arranged to project spray in all directions for complete coverage

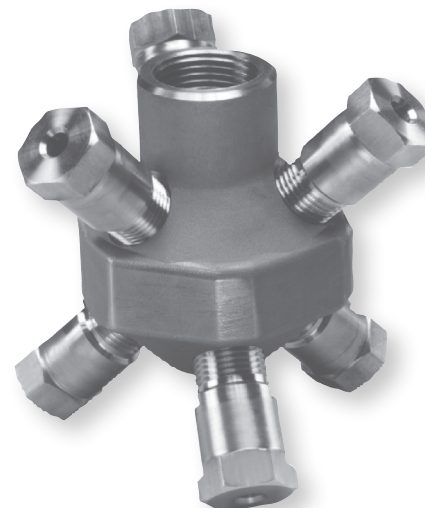

SPRAY CHARACTERISTICS

Spray Angles: 360°

Flow Rates: 28.1 to 290 L/min (Special flow rates available)

Max Temperature: 288° C

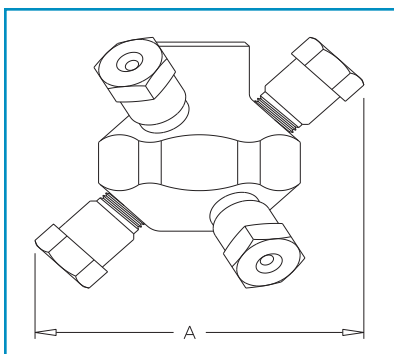

DIMENSIONS IN MILLIMETERS

Pipe Size	Overall Diameter A	Weight (kg)	
		Metal	Plastic
3/4"	120	1.3	0.2
1"	146	2.3	0.4

CLUMP FLOW RATES

Materials: 316 Stainless Steel and Brass.

Female Connection Type	Nozzle Number	Spray Angles	K Factor	Flow Rate (L/min) @ Differential Pressure (bar)						Scrubbing Dia	Rinsing Dia
				0.7	1	2	3	4	5		
				bar	bar	bar	bar	bar	bar		
3/4" FNPT/BSP	CLUMP-125	360°	33.2	28.1	33.2	46.0	55.6	63.7	70.8	1	2
	CLUMP-156		52.7	44.6	52.7	73.2	88.2	101	112	1	4
	CLUMP-187		76.2	65.7	76.2	106	128	146	163	2	4
1" FNPT/BSP	CLUMP-187	360°	76.2	65.7	76.2	106	128	146	163	2	4
	CLUMP-218		121	103	121	168	203	232	258	2	4
	CLUMP-250		136	115	136	188	228	261	290	3	5

Flow Rate (GPM) = $K\sqrt{PSI}$

Spray angle performance varies with pressure. Contact BETE for specific data on critical applications.

For special flow rates contact BETE.

Other materials available on request.



LEM

STATIONARY MANIFOLD

Soil Class: 1 & 2

DESIGN FEATURES

- Each nozzle in the stationary manifold is a BETE TF clog-resistant spiral nozzle
- Other BETE nozzles can be used
- Six nozzles arranged to project spray in all directions for complete spray coverage

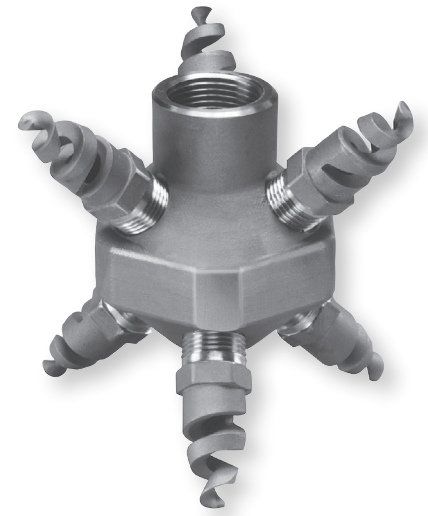

SPRAY CHARACTERISTICS

Spray Angles: 360°

Flow Rates: 16 to 597 L/min (Special flow rates available)

Max Temperature: 288° C

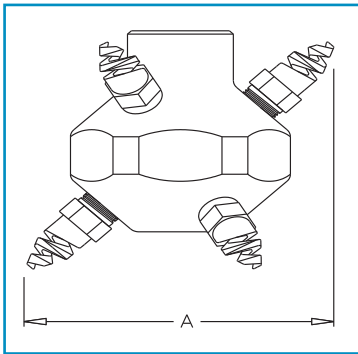

DIMENSIONS IN MILLIMETERS

Connection Size	Overall Diameter A	Weight	
		Metal (lbs.)	Plastic (oz.)
3/4"	4.50	2.2	6.0
1"	5.25	4.1	11.0

LEM FLOW RATES

Materials: Brass, 316 Stainless Steel

Female Connection Type	Nozzle Number	Spray Angles	K Factor	Flow Rate (L/min) @ Differential Pressure (bar)								Scrubbing Dia	Rinsing Dia
				0.7	1	1.5	2	3	4	5	7		
				bar	bar	bar	bar	bar	bar	bar	bar		
3/4" FNPT/BSP	LEM-6	360°	19.1	16.0	19.1	23.4	27.1	33.2	38.3	42.8	50.6	0.5	1
	LEM-8		36.5	30.5	36.5	44.7	51.6	63.2	72.9	81.5	96.5	1	2
	LEM-10		57.0	47.7	57.0	69.8	80.6	98.7	114	127	151	1	3
1" FNPT/BSP	LEM-12	360°	82.0	68.6	82.0	100	116	142	164	183	217	2	4
	LEM-14		111	92.7	111	136	157	192	222	248	293	2	4
	LEM-16		144	120	144	176	203	249	287	321	380	2	4
	LEM-20		226	189	226	276	319	391	451	504	597	2	5

Flow Rate (GPM) = $K\sqrt{PSI}$

Spray angle performance varies with pressure. Contact BETE for specific data on critical applications.

For special flow rates and nozzle tips contact BETE.



TANK CLEANING MOUNTING ADAPTER

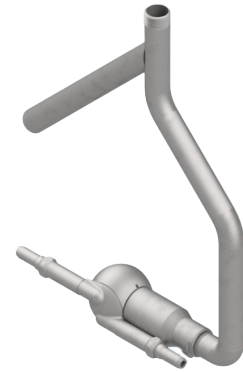

ACCESSORY FOR EFFECTIVELY CLEANING TANKER TRUCKS AND RAILCARS

The tank cleaning mounting adapter positions the HydroWhirl® Orbiter horizontally to optimize the spray pattern's direction to clean the bulkheads repeatedly and effectively.

DESIGN FEATURES

- Reduces cleaning cycle times by up to 50%
- Easy to repair and maintain on-site
- Eliminates the need for manual cleaning
- Designed to protect the nozzle from damage upon insertion and removal
- Designed to fit HydroWhirl Orbiter 1 1/2" NPT/BSP connection sizes

SPRAY CHARACTERISTICS

Spray Angles: Complete 360° spray

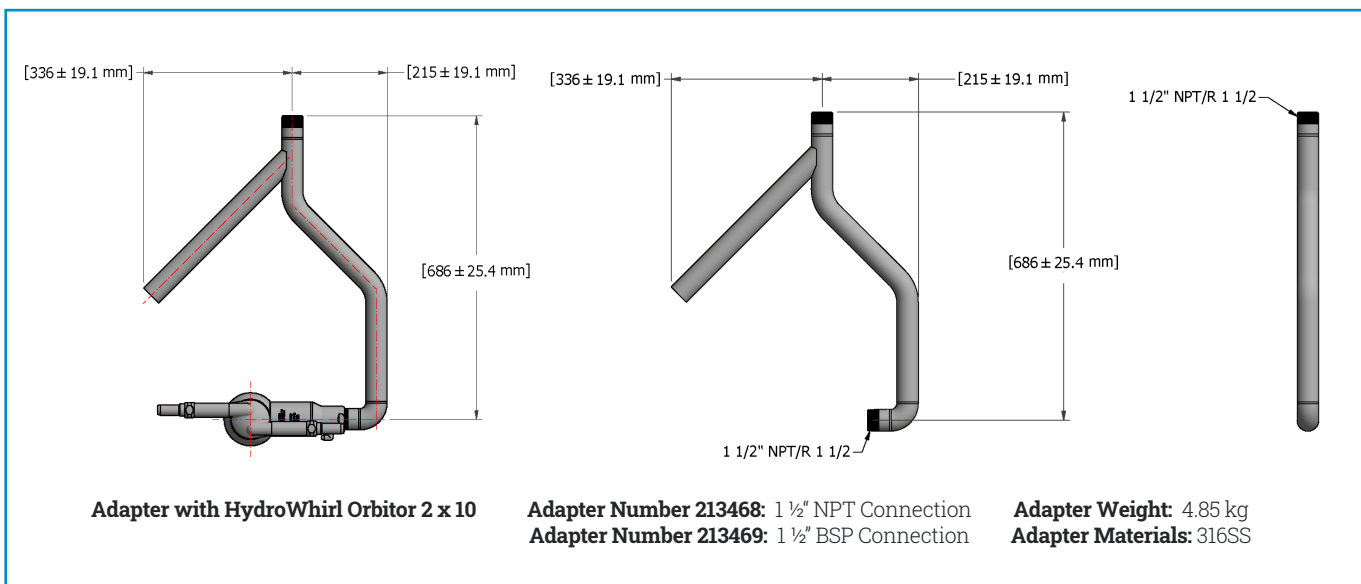

* For flow rate information refer to HydroWhirl® Orbiter datasheet

TANK CLEANING LANCES

CUSTOM SPRAY TECHNOLOGY FABRICATIONS FOR OPTIMAL NOZZLE PLACEMENT

BETE tank cleaning lances provide a custom engineered solution for optimal placement of a tank cleaning nozzle inside a tank. All lances are custom designed and fabricated at BETE to ensure close coordination through all phases for optimal nozzle performance.

Lance designs can be symmetrical or asymmetrical and may include a retractable feature for Clean-In-Place (CIP) or Clean-Out-of-Place (COP) applications. Add a customized lance for any BETE tank cleaning nozzle option.

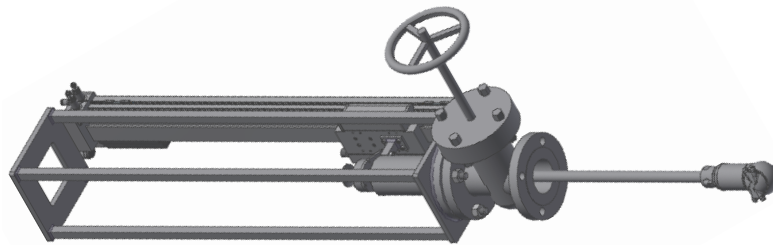

RETRACTABLE LANCES

Retractable lances allow you to withdraw your tank cleaning nozzle, isolate it from the process, and remove it entirely for servicing without stopping your production process.

DESIGN & FABRICATION

Our engineers start by incorporating all your project specifications to ensure we meet your design requirements and validate any industry codes that must be compliant.

BETE can provide assemblies manufactured to ASME B31.3 Code for Process Piping and other applicable ASME Codes/Standards. If you require certain certifications or require your assembly to comply with applicable codes, please contact BETE.

Materials of Construction

- PVDF, PTFE, 316SS, 316L SS, nickel alloys, and other exotic alloys
- Polished finish for sanitary requirements



CHOOSE THE RIGHT PARTNER FOR YOUR TANK CLEANING REQUIREMENTS

Understanding nozzle performance and how a spray behaves in your tank cleaning application is critical. Every phase from design and manufacturing to testing and quality assurance is performed in-house, ensuring close coordination through each stage to meet all mechanical and performance requirements.

MANUFACTURING SERVICES

Our state-of-the-art manufacturing facility utilizes various manufacturing processes to produce standard or custom nozzles and tailored spraying solutions for specific application requirements. We attribute the driving force behind all of this to our highly qualified employees. They respond to the needs of our customers – ensuring that performance, quality, and delivery expectations are all met.

SPRAY FABRICATION SERVICES

Many industries have counted on BETE's nozzle engineering expertise for decades to supply fabricated spray assemblies designed from the nozzle up. Starting with the process conditions, we recommend the most appropriate nozzle and incorporate it into a fabricated tank cleaning lance.



Working with BETE as your primary fabricator ensures all components fit and work together seamlessly. Our welding department, which is fully qualified to ASME B & PV Code Section IX, has made a specialty of joining dissimilar metals.

ENGINEERING SERVICES

APPLICATIONS ENGINEERING

BETE Applications Engineers can assist you when your application requires a custom-designed nozzle, involves precise spray performance, or unusual operating conditions. Our engineers have decades of combined experience in nozzle design and process specification.

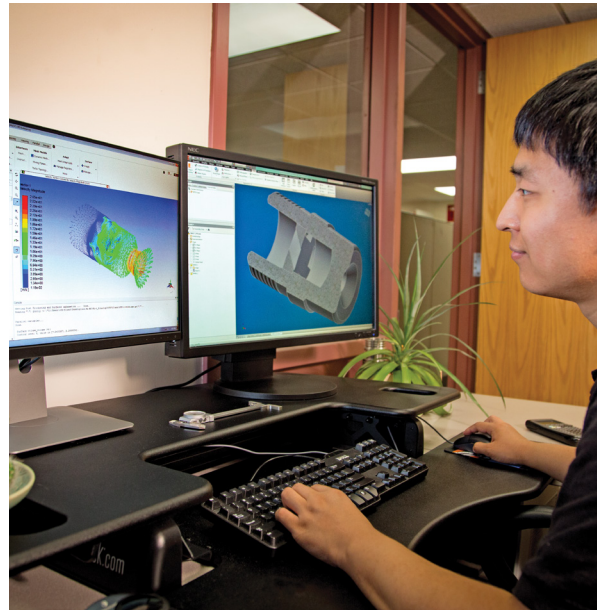

DESIGN ENGINEERING

BETE's advanced CIM (Computer Integrated Manufacturing) environment links our in-house design engineering team's CAD workstations with a CAM part programming system and CNC machine tools. The spray engineering group works with our manufacturing and design engineering teams to help you design your process or solve your spray problem. Through cross-department collaboration, we ensure that the result is manufacturable and cost-effective.

3D CAD MODELS

Accelerate your design time and improve engineering accuracy with our free, on-demand 3D CAD solid models configuration available on our website for select nozzle series. Choose from over 100 CAD formats and versions to download a 3D spray nozzle and virtually test it within your design

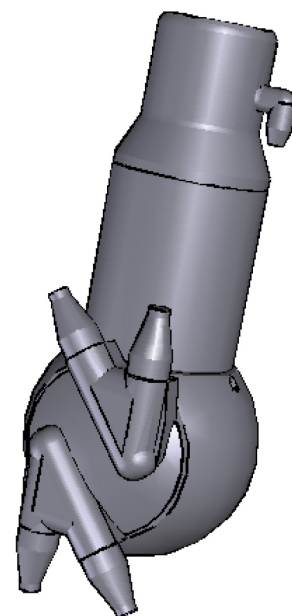

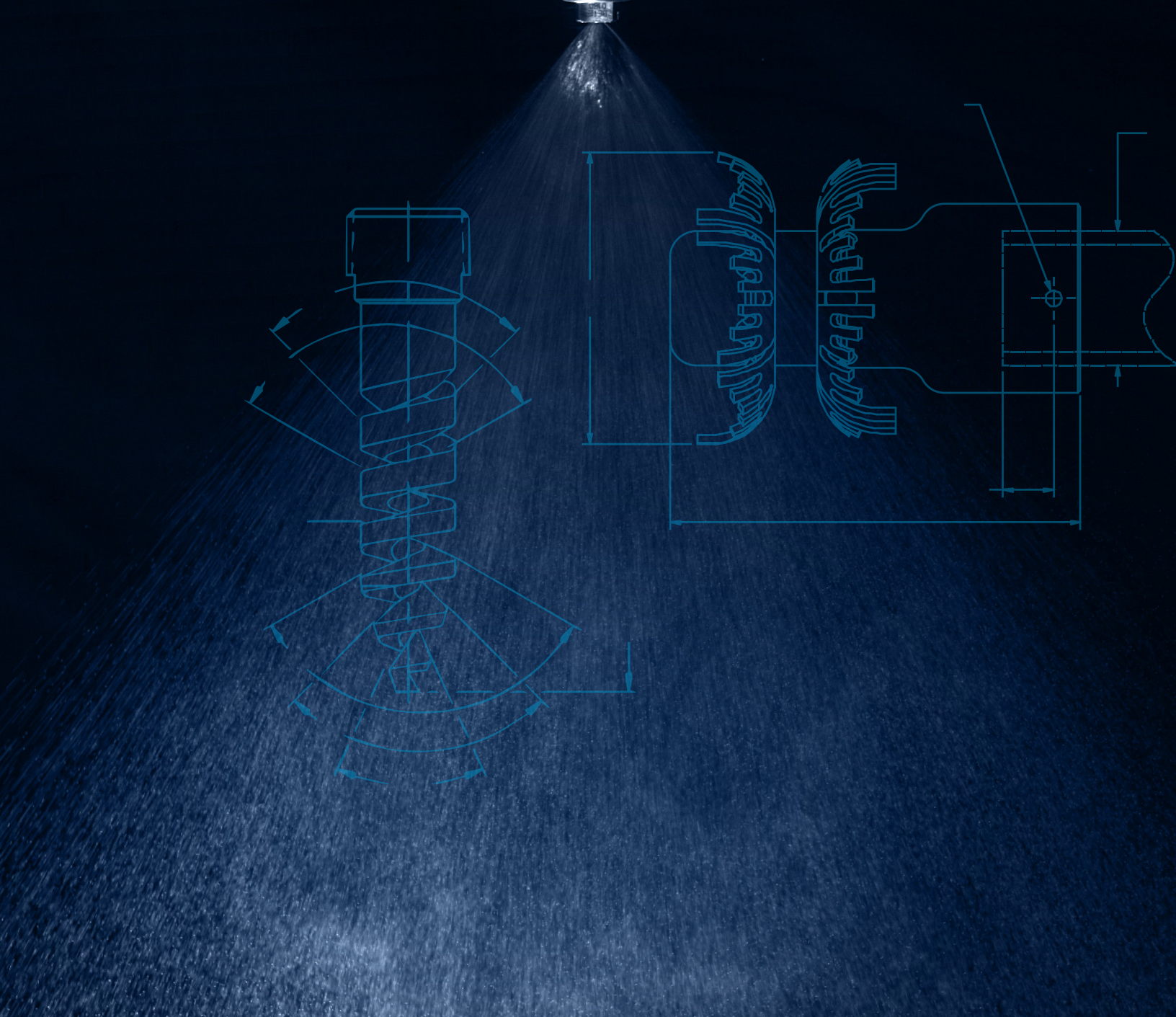

BETE Fog Nozzle, Inc.
50 Greenfield Street, Greenfield | MA 01301 USA
413-772-0846 | www.BETE.com | sales@BETE.com



Spray
Nozzles



Spray
Fabrications



Spray
Systems



Applications
Engineering



Spray
Research